

M12-A-5

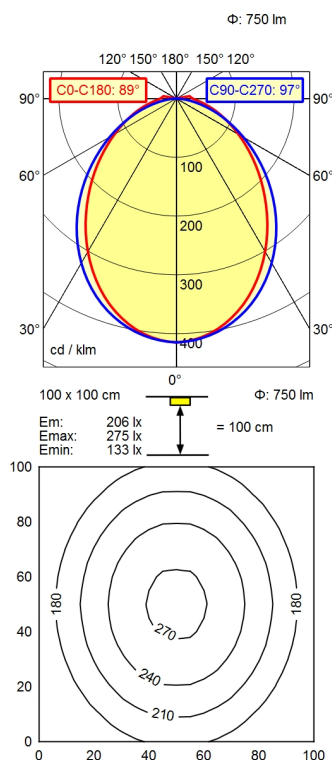

light source  
work equipment  
connected load  
power consumption  
luminous flux  
luminous efficiency  
light distribution  
beam angle  
colour temperature  
glare control  
system of protection  
class of protection  
technology  
operation  
housing  
cover  
weight (net)  
mains lead  
design  
fastening  
dimension

LED  
without  
22-26 V, DC  
env. 15,0 W  
approx. 750 lm  
approx. 50 lm/W  
direct  
89° / 97°  
yellow  
screen  
IP 54  
III  
switchable  
external  
aluminium/plastic; anodised, painted; aluminium  
coloured anodised  
Acrylic satine  
env. 0,329 kg  
built-in plug; M12-A-5  
mounted version  
bracket  
A=755mm,Cmin=710mm,Cmax=740mm